

## An Optimized Adaptive Filtering for Speech Noise Cancellation

Dr. Ahlam Fadhil Mahmood

[ahlam.mahmood@gmail.com](mailto:ahlam.mahmood@gmail.com)

Mohammad Qasim Hayder

[mohammad\\_q\\_aziz@yahoo.com](mailto:mohammad_q_aziz@yahoo.com)

Computer Engineering Department  
University of Mosul

### Abstract

The main interest in adaptive filters continues to grow as they begin to find practical applications in areas such as channel equalization, echo cancellation, noise cancellation and many other adaptive signal-processing applications. The work presented in this paper focuses on optimizing most popular adaptive filtering algorithms namely Least Mean Square (LMS) algorithm, Normalized Least Mean Square (NLMS) and Recursive least Squares (RLS) by using genetic optimizer approach. The tap-length are updated with the three adaptive algorithms according to the value of mean square error based on genetic style. The simulation results for noise cancellation in speech enhancement demonstrate the good performance of the proposed algorithm in attenuating the noise with less hardware resources complexity. It is a nice tradeoff between hardware complexity, SNR ratio and the convergence speed.

*Keywords: Adaptive Filter, LMS, NLMS, RLS, GA, Noise Cancellation*

### المرشحات التكيفية المُثلى للإلغاء ضوضاء الكلام

محمد قاسم حيدر

[mohammad\\_q\\_aziz@yahoo.com](mailto:mohammad_q_aziz@yahoo.com)

د. أحلام فاضل محمود

[Ahlam.mahmood@gmail.com](mailto:Ahlam.mahmood@gmail.com)

قسم هندسة الحاسوب  
جامعة الموصل

### الخلاصة

أن الاهتمام في مرشحات التكيف بتزايد مستمر لضرورتها وجودها في العديد من التطبيقات العملية وفي مجالات شتى مثل موازنة القناة، إلغاء الصدى، وإلغاء الضوضاء بالإضافة للعديد من التطبيقات الأخرى لمعالجة الإشارات التكيفية. العمل المقدم في هذه الورقة يتضمن تحسين الخوارزميات التكيفية الثلاث الأكثر شعبية وهي خوارزمية ال (LMS) أقل معدل تربيع للخطأ ، و (NLMS) تطبيع بأقل معدل مربع للخطأ المعدلة وال (RLS) خوارزمية النهايات الصغرى للمربعات التكرارية باستخدام النهج الوراثي محسن. يتم تحديث طول رتبة المرشح للخوارزميات التكيفية الثلاثة وفقاً لقيمة متوسط مربع الخطأ على أساس النمط الجيني. نتائج المحاكاة المأخوذة لإلغاء الضجيج لتحسين الخطاب دلت على الأداء الجيد للخوارزمية المقترحة في التقليل من الضوضاء إلى جانب تقليل الموارد المُستخدمة لبناء المرشحات. حيث أعطت تناسق جيد بين تقليل تعقيد الأجهزة وسرعة التقارب إلى جانب زيادة نسبة الإشارة إلى نسبة الضوضاء.

Received: 4 – 5 - 2014

Accepted: 18 – 12 - 2015

## 1. Introduction

Signal carries of both useful and unwanted information and therefore extracting the valuable information from a mixture of conflicting information is highly needed in any signal processing application. Hence, the signal has to be cleaned up with noise cancellation technique before it is stored, analyzed, transmitted, or processed [1]. The foremost task in any signal processing application is to offer the optimal input signal for the system. In recent years, with the wide development of digital signal processing (DSP) tools, adaptive filtering techniques have become standard solutions for this issue. Adaptive filter is a filter that self-adjusts its transfer function according to an optimization algorithm driven by an error signal. Because of the complexity of the optimization algorithms, most adaptive filters are digital filters [2].

Adaptive filters learn the characteristics of their environment and continually adjust their parameters accordingly. Because of their ability to perform well in unknown environments and track statistical time variations, adaptive filters are employed in a wide area of fields. The adjustable parameters that are dependent on the applications are the number of filter taps, choice of training algorithm, and the convergence speed (learning rate) [3]. There are various algorithms involved for the filtering depending upon the applications and the requirements. The most popular adaptive algorithms are the Least Mean Square (LMS) algorithm, Normalized Least Mean Square (NLMS) algorithm and the Recursive Least Square (RLS) algorithm. In the communication industry, there is a lot of literature that proposed the use of LMS, NLMS and RLS algorithm for channel estimation, equalization, and demodulation [4],[5],[6],[7],[8],[9]. The performance of these adaptive algorithms is highly dependent on their filter order and signal condition. Furthermore, two things are to be considered: (a) errors in optimal cases and (b) the convergence rate speed. Several different structures stochastic optimization techniques can be found in adaptive filtering literature. Most notably simulated annealing [10], evolutionary algorithms such as the genetic algorithm [11],[12], and swarm intelligence algorithms such as particle swarm optimization [13]–[14]. As tap-length and weights both get changed over times and they are the key parameters to control the error and convergence rate, both are required to be updated over times. So, the duo adaptation procedure based on genetic algorithm is proposed in this paper in order to speed up the algorithm convergence.

The paper is organized as follows. Section 2 explains the basic concepts LMS, NLMS and RLS adaptive algorithms in general, section 3 presents the concept of genetic adopted algorithms for this research work, section 4 investigates the experimental results and section 5 deals with the performance evaluation of the above work. Finally, the conclusion is summarized in section 6.

## 2. Adaptive Algorithms(AF)

Adaptive filters perform digital signal processing and adapt their performance based on the input signal. Figure 1 shows the basic block diagram of the Adaptive FIR filter. Where  $x(n)$  is the input signal,  $y(n)$  is the output filter response, and  $d(n)$  is the desired signal.

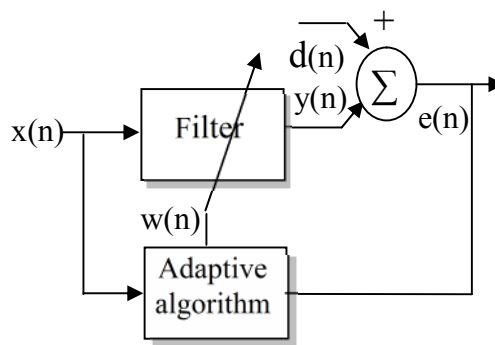


Figure 1: Block diagram of General adaptive filter

In this Figure the input signal are connected to the variable filter and gives a output signal, the error signal  $e(n)$  can minimize the error by separating the actual output and desired signal by adjusting the filter coefficient. The minimization of the objective function implies that the adaptive filter output signal is matching the desired signal in some sense. widely used algorithms are applied to the noisy signals for enhancement and they are explained below.

### 2.1 The Adaptive LMS Algorithm

One of the most used algorithm for adaptive filtering is the LMS algorithm developed by Widrow and Hoff. It is a gradient descent algorithm and it adjusts the adaptive filter taps modifying them by an amount proportional to the instantaneous estimate of the gradient of the error surface [1]. Minimization of mean square error is achieved due to the iterative procedure incorporated in it to make successive corrections in the direction of negative of the gradient vector it is represented in following steps [1, 8].

1. Calculates the output signal  $y(n)$  from the adaptive filter.
2. Calculates the error signal  $e(n)$  by using the following equation (1)

$$e(n) = d(n) - y(n) \dots\dots\dots (1)$$

Updates the filter coefficients by using the following equation (2)

$$\bar{w}(n + 1) = \bar{w}(n) + \mu \cdot e(n) \cdot \bar{u}(n) \dots\dots\dots (2)$$

Where  $\mu$  is the step size of the adaptive filter,  $\bar{w}(n)$  is the filter coefficients vector, and  $\bar{u}(n)$  is the filter input vector [8]. LMS algorithms adjust the filter coefficients to minimize the cost function.

### 2.2 The Adaptive NLMS Algorithm

The NLMS algorithm is a modified form of the standard LMS algorithm. This algorithm takes into account variation in the signal level at the filter output and selecting the normalized step size parameter that results in a stable as well as fast converging algorithm. The weight update relation for NLMS algorithm is as follows

$$\bar{w}(n + 1) = \bar{w}(n) + \mu \cdot e(n) \cdot \frac{\bar{u}(n)}{\|\bar{u}(n)\|^2 + c} \dots\dots\dots (3)$$

where  $\mu(n) = \mu / \|\bar{u}(n)\|^2 \dots\dots\dots (4)$

and  $c$  is small constant

The NLMS algorithm works same as the standard LMS algorithm except that it uses time-varying step size  $\mu(n)$ . The advantage of this varying step size will improve the convergence rate but the strength of the signal is still maintained. In contrast to LMS algorithm, the error signal is comparatively smaller in NLMS [15]. Also it is observed that the convergence rate of the NLMS algorithm is greater than that of the standard LMS algorithm because of multiplication operations.

### 2.3 Recursive Least Squares (RLS) algorithm

The RLS filter overcomes some practical limitations of the LMS filter by providing faster rate of convergence and good performance. RLS algorithm has the potential to automatically adjust the coefficients of a filter, even though the statistics measures of the input signals are not presented. This algorithm performs at each instant an exact minimization of the sum of the squares of the desired signal estimation errors [1], [9]. Since it utilizes all the information contained in the input data, the estimation is updated recursively when the arrival of new sample. The steps involved in RLS algorithm are given below.

Initialize the algorithm by setting

$$\bar{w}(0) = 0,$$

$$p(0) = \delta^{-1}I, \text{ where } I \text{ represents the identity matrix.}$$

$$\delta = \begin{cases} \text{small positive constant for high SNR} \\ \text{large positive constant for low SNR} \end{cases}$$

For each instant of time,  $n=1,2,\dots$ , compute

$$\pi(n) = p(n-1)u(n),$$

$$k(n) = \frac{\pi(n)}{\lambda + u^H(n)\pi(n)},$$

$$e(n) = d(n) - \bar{w}^H(n-1)u(n),$$

$$\bar{w}(n) = \bar{w}(n-1) + k(n)e(n),$$

and

$$p(n) = \lambda^{-1}p(n-1) - \lambda^{-1}k(n)u^H(n)p(n-1)$$

Where,  $w(n)$  = filter coefficients,  $k(n)$ =gain vector,  $\lambda$ =forgetting factor,  $P(n)$ =inverse correlation matrix of the input signal,  $p(n)$ =positive constant.

### 3. Genetic Algorithm

Genetic algorithm (GA) is an evolutionary optimization technique that mimics living systems with computers emulated solutions. It encodes a potential solution to a specific problem on a chromosome-like data structure and applies recombination operators to these structures in a manner that preserves critical information. Reproduction opportunities are applied in such a way that those chromosomes representing a better solution to the target problem are given more chances to reproduce than chromosomes with poorer solutions [12], [11].

Typically, a GA is composed of two main components: the encoding problem and the evaluation function. The encoding problem involves generating an encoding scheme to represent the possible solutions to the optimization problem. The evaluation function measures the quality of a particular solution.

Chromosomes evolve through successive iterations, called generations. To create the next generation, new chromosomes, called offspring, are formed by (a) merging two chromosomes from the current population together using a crossover operator or (b) modifying a chromosome using a mutation operator. Crossover, the main genetic operator, generates valid offspring by combining features of two parent chromosomes. Chromosomes are combined together at a defined crossover rate, which is defined as the ratio of the number of offspring produced in each generation to the population size. Mutation, a background operator, produces spontaneous random changes in various chromosomes. Mutation serves the critical role of either replacing the chromosomes lost from the population during the selection process or introducing

new chromosomes that were not present in the initial population. The mutation rate controls the rate at which new chromosomes are introduced into the population.

### 4. The Proposed adaptive Filters(GAF)

Tap-length plays an important role in the design of adaptive Filters, which has been utilized in a wide range of applications as a consequence of its simplicity and robustness. However, in many applications the tap-length of the adaptive filter is for simplicity assumed to be fixed, which is not suitable for certain situations where the optimal tap-length of the system filter is unknown or variable[16]. Furthermore, it is well known that the selection of tap-length significantly influences the performance of adaptive filters: deficient tap-length is likely to result in increase of the minimum mean square error; whereas the computational cost and the excess mean square error may become too high if the tap-length is too large. Utilizing genetic algorithms for the tap-length adaptation, the optimal GAF algorithm has been proposed and it is formulated as flowchart shown in figure 2.

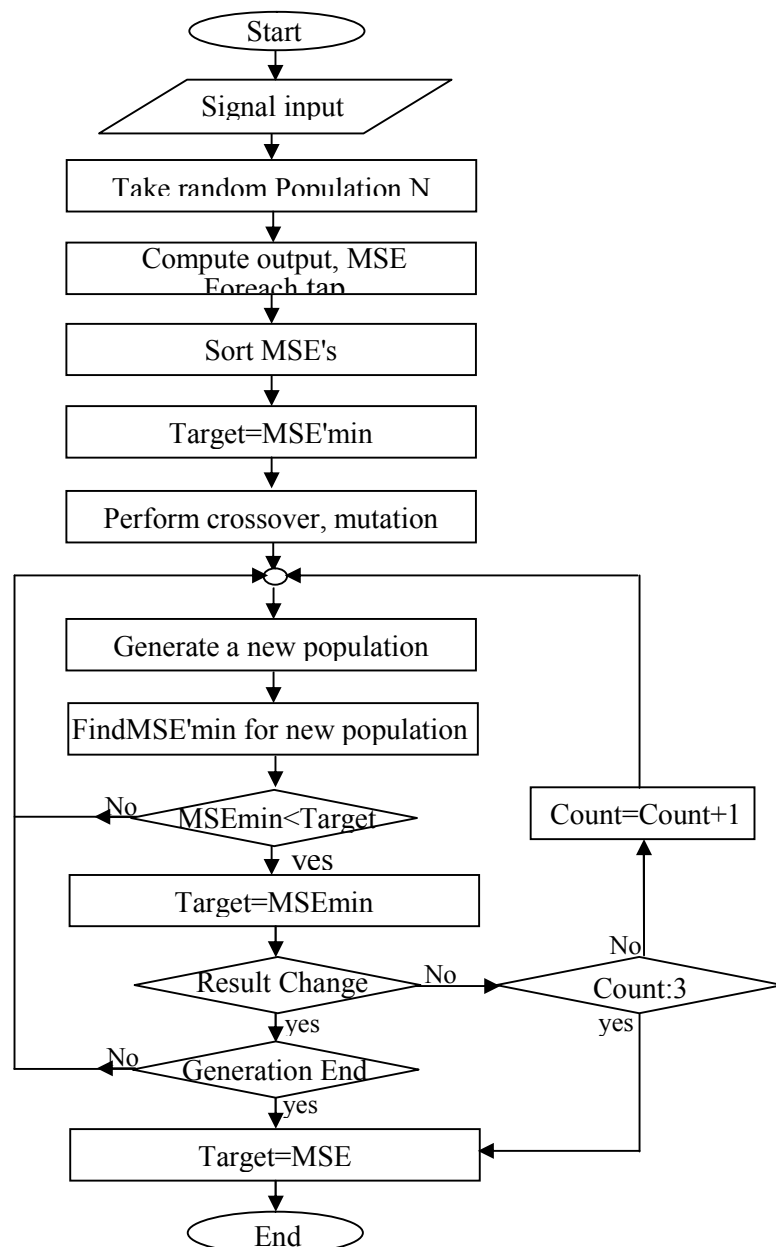
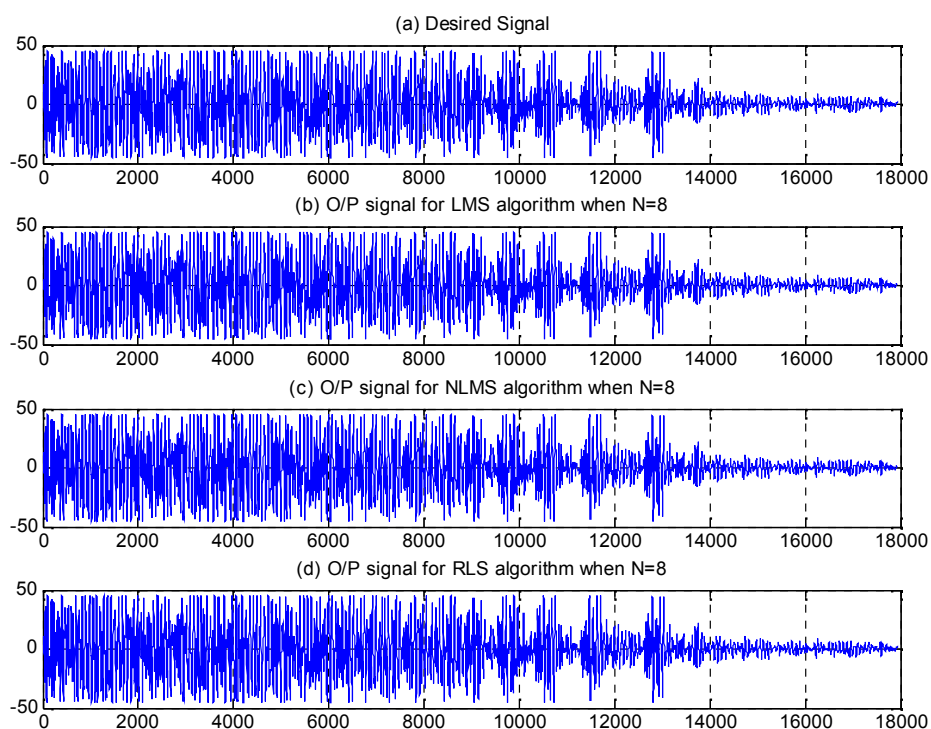


Figure 2: Flow Chart of GAF algorithm for tap-length adaptation

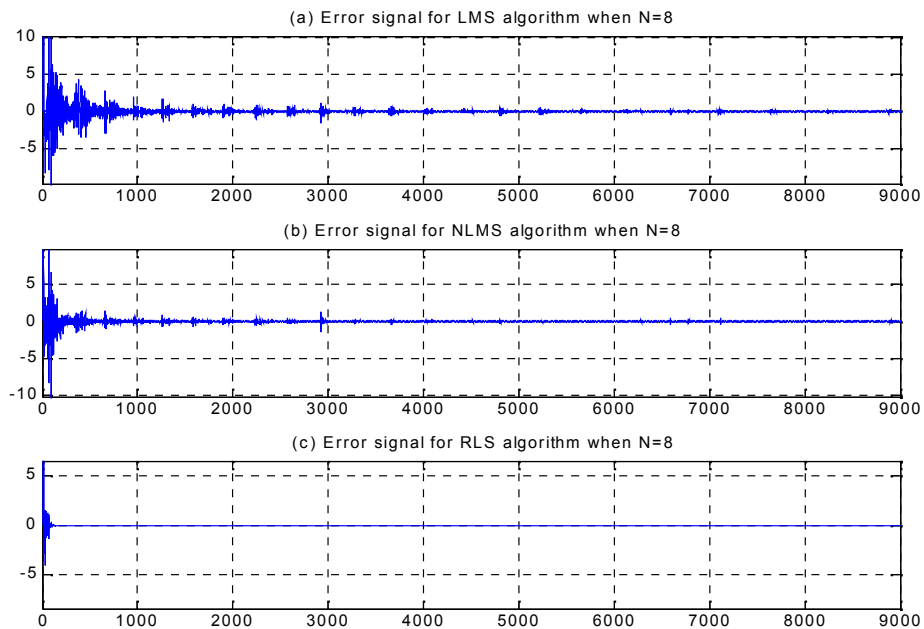
## 5. Experimental Results

The performance of the proposed technique is validated by considering two unknown filter function, the first transfer function is  $h=[1, 2.5, 5.25, 2.5, 1, 0.9, 1.2, 0.9, 1.5, 2]$ . The optimal outputs and the error signal of the first filter using LMS, NLMS and RLS for 18000 samples are shown in Figure: 3, 4 respectively. The order of the filter was set to  $N=15$ , while the proposed GAF verify it optimal value of  $N$  was equal to 8. The  $\mu$  parameter was set to 0.01 in the LMS, NLMS and RLS algorithms.

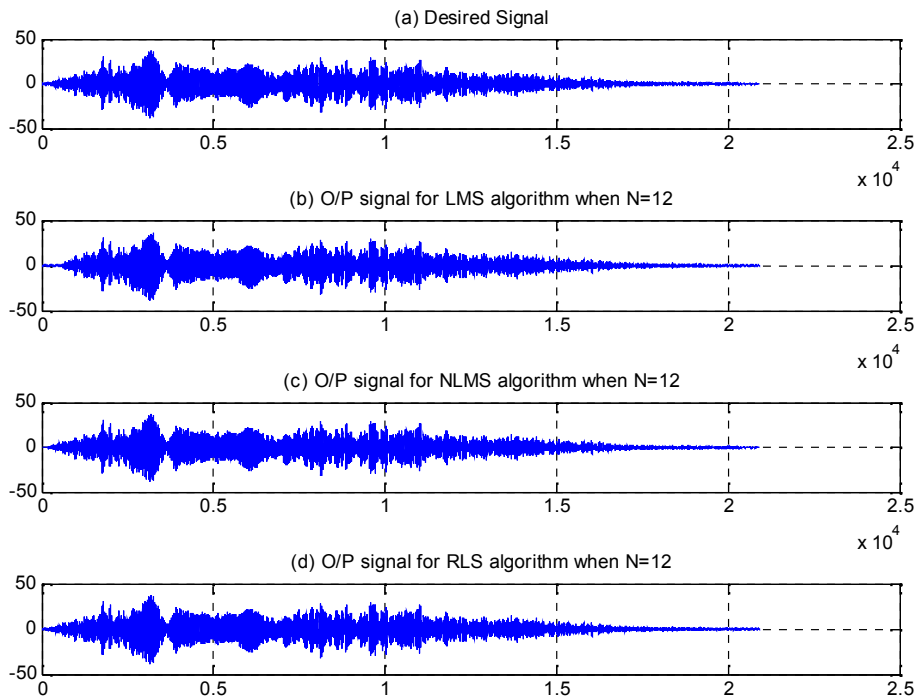
The second filter was used  $h=[0.1, 0.33, 0.6, 0.22, 2.2, 5.2, 2.44, 4.52, 3.21, 0.1, 1.2, 0.2, 0.5, 2.5]$  with 25 tap and the proposed optimized style minimized it to 12 only for three adaptive filters and same  $\mu$  parameter. The twelve tap optimal solution for noise cancellation of for all adaptive algorithms.



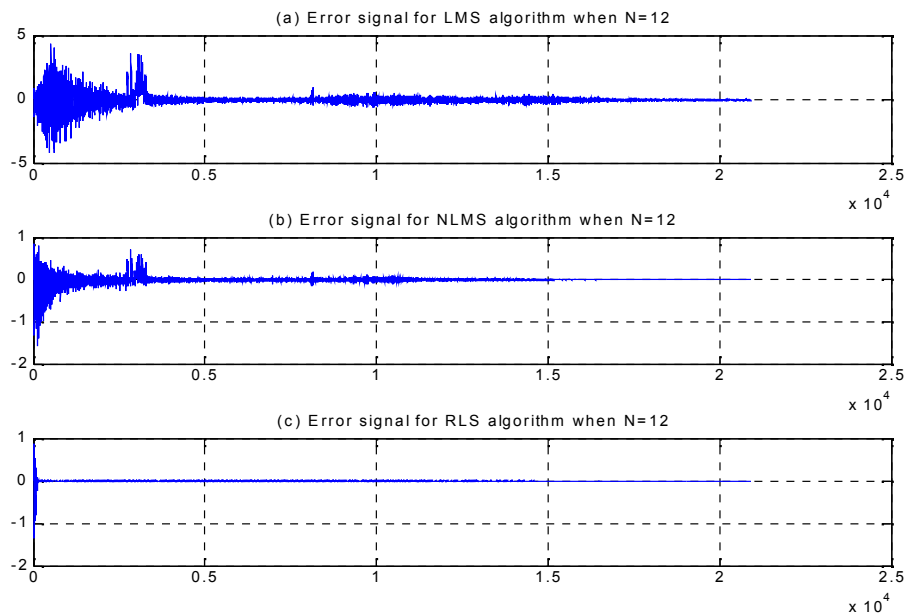
**Figure 3:(a) Noisy speech desired signal  $d(n)$ ;(b)The simulation of the GAF( LMS) algorithm is carried out with the following specifications:  $N=8$  optimal solution, step size  $\mu= 0.01$  and iterations=18000; (c) NLMS output for same parameters; (d) RLS output filter.**



**Figure 4:(a) The LMS optimal error signal  $e(n)$ ; (b)The NLMS Optimal error signal;**

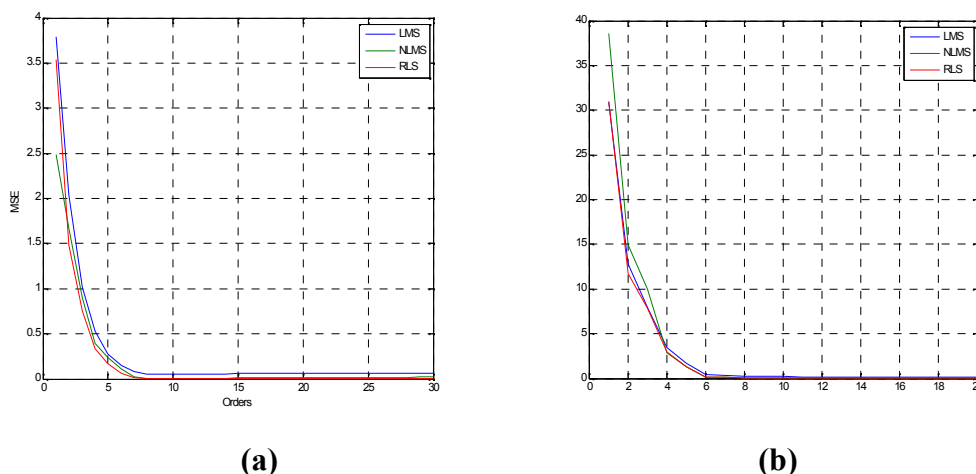


**Figure 5:(a) Noisy speech desired signal  $d(n)$ ;(b)The simulation of the GAF( LMS) algorithm is carried out with the following specifications: N=12 optimal solution, step size  $\mu= 0.01$  and iterations=250000; (c) NLMS output for same parameters; (d) RLS output filter.**



**Figure 6:(a) The LMS optimal error signal  $e(n)$ ; (b)The NLMS optimal error signal;(c)RLS error signal**

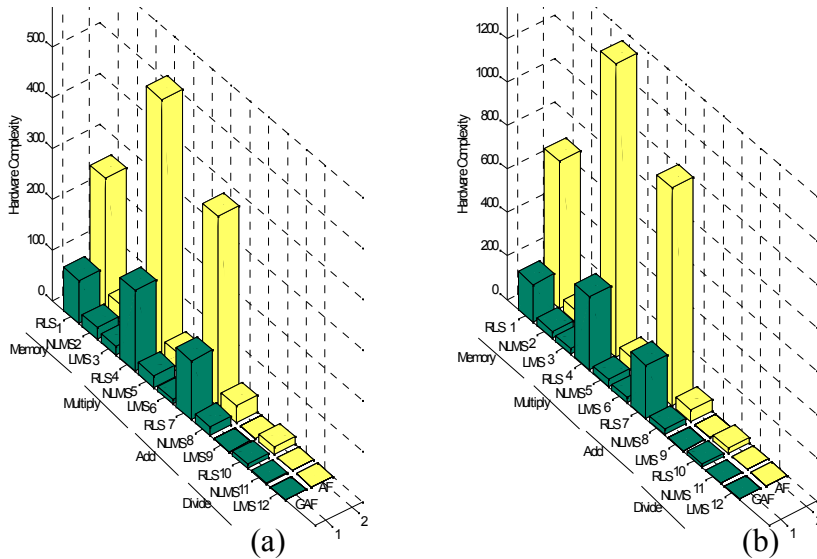
From each generations, one tap-length having least MSE is recorded. After endof generations or reach three trail unchanged results, best suited tap-lengths have been plotted with corresponding MSE for three adaptive algorithms as shown in Figure 7. While tap-length getting updated tap-weights also get updated by the GAF adaptive algorithms and for every individual tap-length the MSE is estimated taking the newer MSE target. The MSE taking from the samples for every individual tap-length are calculated and least MSE of every generation has founded. For the testing signal first optimal filter gets least MSE in 8<sup>th</sup> order and it does not change until filter is changed, second testing filter has least MSE taking 12<sup>th</sup> order .



**Figure7:(a) First filter MSE learning curve with respect to corresponding Tap-length for the first case ; (b) is for the second case**

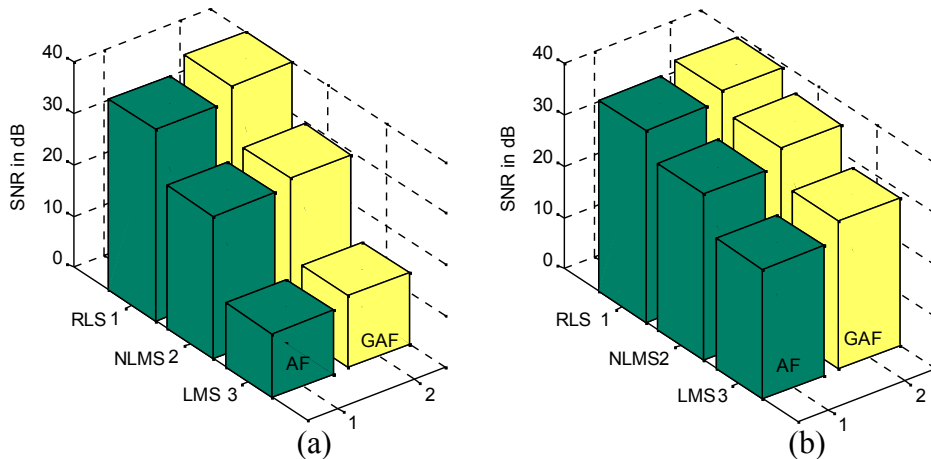


Optimal tap-length determination reduces the hardware computational complexity which is desirable to be minimized in time varying environment as training phase is executed time to time. The hardware resource reduction of the two filters is shown in figure: 7 as mentioned in reference[17].



**Figure8:(a) The resources required to implement the LMS, NLMS and RLS algorithms for first GAF filter compared with AF;(b)The second hardware resources for GAF and AF.**

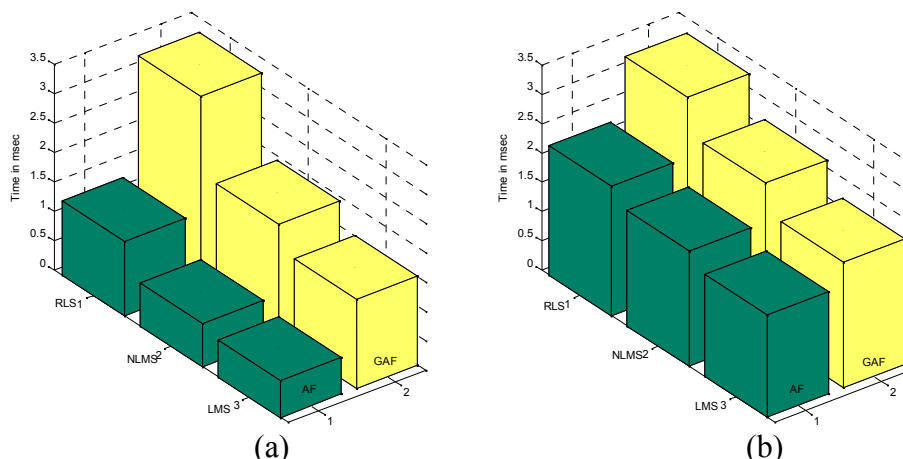
Besides Figure 8 shown that GAF RLS outperforms NLMS and LMS algorithms needed lower hardware complexity, higher signal to noise ratio can be achieves as verify in figure 9.



**Figure 9:(a) Performance Evaluation of first LMS, NMLS and RLS filters using GAF and AF based on SNR; (b)Second SNR Filters for GAF and AF**

The proposed GAF based on genetic algorithm that has need a lot amount of time during which it can be run rather than AF for three algorithms, the population size has to be optimized depending on the number of generations. In the two testing filters

Figure 10 demonstrate the time compression for the proposed GAF with fixed tap-length AF.



**Figure 10:(a)Time needed for first LMS, NMLS and RLS filters using GAF and AF; (b)Second filters time amount for GAF and AF.**

## 6. Conclusion

In this paper, adaptive filters using LMS, NLMS and RLS algorithms have been accomplished based on optimized the tap-length for speech noise cancellation. Among these, LMS algorithm is a very simple and effective method to implement though it is a slower one. Even though, with increased step size, the rate of convergence obtained in NLMS is not up to the satisfactory level. The experimental results show that the optimal RLS has a better convergence and it also provides better noise reduction with improved speech quality and intelligibility when compared to the other algorithms. As a result, with these appropriate settings of the adaptive filter parameters, this optimal style can be employed for the speech enhancement system with lower hardware resources and higher SNR compared with conventional adaptive filters.

## References:-

- [1]Vimala.C and Radha.V, "Optimal Adaptive Filtering Technique for Tamil Speech Enhancement", International Journal of Computer Applications (0975 – 8887) Volume 41– No.17, pp. 23-29, March 2012.
- [2]S. Chaudhary, R. Mehra, "FPGA Based Adaptive Filter Design Using Least PTH-Norm Technique", International Journal of Soft Computing and Engineering (IJSCE) ISSN: 2231-2307, Volume-3, Issue-2, pp.208-211, May 2013.
- [3]O. S. Tehrani, M. Ashourian and P. Moallem, "FPGA Implementation of a Channel Noise Canceller for Image Transmission", Conference on Machine Vision and Image Processing, 2010 6th Iranian, pp.: 1-6, IEEE Publisher, 2010.
- [4]S. Arunkumar, P Parthiban and S.Aravind Kumar, "Implementation of Least Mean Square Algorithm for Sinusoidal and Audio Denoising using FPGA", International Journal of Advanced Research in Electrical, Electronics and Instrumentation Engineering, Vol. 2, Issue 12, pp. 5843-5850, December 2013.

- [5]K. R. Rekha, B. S. Nagabushan and K.R.Nataraj, "FPGA Implementation of NLMS Algorithm for Identification of unknown system", International Journal of Engineering Science and Technology, Vol. 2(11), pp. 6391-6407, 2010.
- [6]J. Dai and Y. Wang, "NLMS Adaptive Algorithm Implement Based on FPGA", 3rd International Conference on Intelligent Networks and Intelligent Systems(ICINIS), Shenyang, China, pp. 422-425, 01 Nov - 03 Nov 2010.
- [7]K. Belpatre, Bachute .M.R, "Comparative performance study between the Time-varying LMS (TVLMS) algorithm, LMS algorithm and RLS algorithm", National Conference on Innovative Paradigms in Engineering & Technology (NCIPET-2012) Proceedings published by International Journal of Computer Applications (IJCA), pp. 6-10, 2012.
- [8]J. Yadav, M. Kumar, R. Saxena and A. K. Jaiswal, "Performance Analysis of LMS adaptive FIR filter and RLS adaptive FIR filter for noise cancellation", Signal & Image Processing : An International Journal (SIPIJ) Vol.4, No.3, p.45-56, June 2013.
- [9] O. P. Sharma, V. Janyani and S. Sancheti, "Recursive Least Squares Adaptive Filter a better ISI Compensator", World Academy of Science, Engineering and Technology 28 2009, p.1031-1036, 2009.
- [10] D. J. Krusienski and W. K. Jenkins, "Design and Performance of Adaptive Systems Based on Structured Stochastic Optimization Strategies", IEEE Circuits and Systems Magazine, pp.8-20, first quarter 2005.
- [11]S. K. Das and N. K. Rout, "A New Technique using GA style and LMS for Structure Adaptation", International Journal of Engineering and Technology (IJET), Vol 5 No 3, pp. 2272- 2276, Jun-Jul 2013.
- [12]H. Takahashi, N. Shaaban, Q. W. Wang, J. Y. Yeom and M. Nakazawa, "Adaptive signal processing with geneticalgorithm optimum filter for fast digitizer ASIC",Nuclear Science Symposium Conference Record, 2003 IEEE (Volume:5 ), pp. 3441- 3443, United States19-25 Oct. 2003.
- [13] M. Shafaati and H. Mojallali, "Modified Firefly Optimization for IIR System Identification", Control Engineering and Applied Informatics, (CEAI), Vol.14, No.4, pp. 59-69, 2012.
- [14]V. D. Mandal, R. Kar, S. P. Ghoshal, "Digital FIR filter design using fitness based hybrid adaptive differential evolution with particle swarm optimization", Natural Computing Vol. 13, Issue1,pp.55–64, March2014.
- [15]A. Srinivasan, "Adaptive Echo Noise Elimination for Speech Enhancement of Tamil letter 'Zha', International Journal of Engineering and Technology Vol.1 (3), pp.91-97, ISSN: 0975-4024, 2009.
- [16]Leilei Li, "Adaptive Algorithms and Variable Structures for Distributed Estimation", Ph D. Thesis, Loughborough University, 2009.
- [17] A. Mousa, M. Qados and S. Bader, "Speech Signal Enhancement Using Adaptive Noise Cancellation Techniques", Canadian Journal on Electrical and Electronics Engineering Vol. 3, No. 7,pp.375-383, September 2012.

**The work was carried out at the college of Engineering. University of Mosul**